

Data Collection Terminal

- RH768 -



User's Manual

400897G Version 1.0

About This Manual

This manual explains how to install, operate and maintain the RH768 Rugged Mobile Computer.

No part of this publication may be reproduced or used in any form, or by any electrical or mechanical means, without permission in writing from the manufacturer. This includes electronic or mechanical means, such as photocopying, recording, or information storage and retrieval systems. The material in this manual is subject to change without notice.

© Copyright 2012 Unitech Electronics Co., Ltd. All rights reserved.

Unitech global website address: <http://www.unitech-adc.com>

Bluetooth is a registered trademark of Bluetooth SIG.



Microsoft, Windows and ActiveSync are either registered trademarks or trademarks of Microsoft Corporation. Other product names mentioned in this manual may be trademarks or Registered trademarks of their respective companies and are hereby acknowledged.



Unitech is a member of Oracle Embedded Software Licensing Program.

Regulatory Compliance Statements

FCC Warning Statement

This equipment has been tested and found to comply with the limits for a Class B digital device, pursuant to part 15 of the FCC rules. These limits are designed to provide reasonable protection against harmful interference in a residential installation. This equipment generates, uses and can radiate radio frequency energy and, if not installed and used in accordance with the instructions, may cause harmful interference to radio communications. However, there is no guarantee that interference will not occur in a particular installation. If this equipment does cause harmful interference to radio or television reception, which can be determined by turning the equipment off and on, the user is encouraged to try to correct the interference by one or more of the following measures:

- Reorient or relocate the receiving antenna.
 - Increase the separation between the equipment and receiver.
 - Connect the equipment into an outlet on a circuit different from that to which the receiver is connected.
 - Consult the dealer or an experienced radio/TV technician for help.
1. This Transmitter must not be co-located or operating in conjunction with any other antenna or transmitter.
 2. This equipment complies with FCC RF radiation exposure limits set forth for an uncontrolled environment. To maintain compliance with FCC RF exposure compliance requirements, avoid direct contact to the transmitting antenna during transmitting.
 3. Any changes or modifications (including the antennas) made to this device that are not expressly approved by the manufacturer may void the user's authority to operate the equipment.

FCC Label Statement

This device complies with part 15 of the FCC rules. Operation is subject to the following two conditions:

1. This device may not cause harmful interference, and
2. This device must accept any interference received, including interference that may cause undesired operation.

RF Radiation Exposure Statement

For body worn operation, this phone has been tested and meets FCC RF exposure guidelines when used with an accessory that contains no metal and that positions the handset a minimum of 1.5 cm from the body. Use of other accessories may not ensure compliance with FCC RF exposure guidelines.

Canadian Compliance Statement

This Class B Digital apparatus meets all requirements of the Canadian Interference-Causing Equipment Regulations.

Cet appareil numérique de la classe B respecte les exigences du Règlement sur le matériel brouilleur du Canada.

European Conformity Statement

Declaration of Conformity with Regard to the R&TTE 1999/5/EC and EMC 89/336/ EEC directives.

RoHS Statement



This device conforms to RoHS (Reduction Of Hazardous Sub-stances) European Union regulations that set maximum con-centration limits on hazardous materials used in electrical and electronic equipment.

TaiwanNCC Warning Statement

交通部電信總局低功率電波輻射性電機管理辦法 (930322)

根據交通部低功率管理辦法規定：

第十二條 經型式認證合格之低功率射頻電機，非經許可，公司、商號或使用者均不得擅自變更頻率、加大功率或變更原設計之特性及功能。

第十四條 低功率射頻電機之使用不得影響飛航安全及干擾合法通信；經發現有干擾現象時，應立即停用，並改善至無干擾時方得繼續使用。前項合法通信，指依電信法規定作業之無線電通信。

低功率射頻電機須忍受合法通信或工業、科學及醫療用電波輻射性電機設備之干擾。

Laser Information

The Unitech RH768 series is certified in the U.S. to conform to the requirements of DHHS/CDRH 21CFR Subchapter J and to the requirements of IEC 825-1. Class II and Class 2 products are not considered to be hazardous. The PA600 series contains internally a Visible Laser Diode (VLD) whose emissions do not exceed the maximum limits as set forth in the above regulations. The scanner is designed so that there is no human access to harmful laser light during normal operation, user maintenance or during prescribed service operations.

The laser safety warning label required by the DHHS/IEC for the PA600 series' optional laser scanner module is located on the memory compartment cover, on the back of the unit.

CAUTION! Use of controls or adjustments or performance of procedures other than those specified herein may result in hazardous laser light. Use of optical instruments with the scanner will increase eye hazard. Optical instruments include binoculars, microscopes, and magnifying glasses. This does not include eyeglasses worn by the user.

Battery Notices

The Unitech RH768 is equipped with a Lithium-Ion Battery Pack and a Backup Battery. However, the RH768 may not start without an external power source due to battery discharge after extended storage periods. To charge the battery to full capacity, connect the RH768 to an external power source with the USB Charging Cable or the Unitech RH768 Cradle. Initially charge the RH768 for at least 16 hours.

The Backup Battery will receive power from an external power source, or through the main battery (But, only if the main battery has adequate power). In order to prevent data loss due to Backup Battery failure, connect the RH768 to the main Battery Pack or an external power source.

NOTE: Turn the RH768 Backup Battery Switch to the ON position before initial use.

Rechargeable batteries are advised to replace every year or when 500 charge/discharge cycles achieved to guarantee optimal performance. It is normal that the battery balloons or expands beyond one year or the maximum of 500 cycles. Although it does not cause harm, it cannot be used again and must be disposed of according to the location's safe battery disposal procedures.

If the performance decrease of greater than 20% in a Lithium-Ion battery, the battery is at the end of its life cycle. Do not continue to use, and ensure the battery is disposed of properly. The length of time that a battery power lasts depends on the battery type and how the device is used. Conserve the battery life through the following:

- Avoid frequent full discharges because this places additional strain on the battery. Several partial discharges with frequent recharges are better than a deep one. Recharging a partially charged lithium-Ion battery does not cause harm because there is no memory.
- Keep the lithium-Ion battery cool. Avoid a hot car. For prolonged storage, keep the battery at a 40% charge level.
- Do not leave the lithium-Ion battery discharged and unused for an extended period because the battery will wear out and the longevity of the battery will be at least shorter than half of the one with frequent recharges.

Battery charge notice

It is important to consider the environment temperature whenever the Lithium-Ion battery pack is charged. Charging is most efficient at normal room temperature or in a slightly cooler environment. It is essential that batteries are charged within the stated range of 32° F - 104°F (0°C - 40°C). Charging batteries outside of the specified range could damage the batteries and shorten their charging life cycle.

CAUTION! Do not charge batteries at a temperature lower than 0°C, which will increase the internal resistance to cause heat and make the batteries unstable and unsafe. Please use a battery temperature detecting device for a charger to ensure a safe charging temperature range.

Storage and safety notice

Although charged Lithium-Ion batteries may be left unused for several months, their capacity may be depleted due to build up of internal resistance. If this happens they will require recharging prior to use. Lithium-Ion batteries may be stored at temperatures between -4F° - 140F° (-20°C to 60°C); however, they may deplete more rapidly at the higher temperature ranges. It is recommended to store batteries within normal room temperature ranges.

Warranty

The following items covered under Unitech Limited Warranty are free from defects during normal use:

- RH768 – 1-year limited warranty.
- Lithium-Ion battery – 6-month limited warranty.

Warranty becomes void if equipment is modified, improperly installed or used, damaged by accident or neglect, or if any parts are improperly installed or replaced by the user.

Use only the adapter supplied. Using the wrong adapter may damage the unit and will void the warranty.

Table of Contents

PREFACE

About This Manual	i
Regulatory Compliance Statements.....	iii
<i>FCC Warning Statement</i>	<i>iii</i>
<i>FCC Label Statement.....</i>	<i>iii</i>
<i>RF Radiation Exposure Statement.....</i>	<i>iii</i>
<i>Canadian Compliance Statement.....</i>	<i>iii</i>
<i>European Conformity Statement.....</i>	<i>iv</i>
<i>RoHS Statement</i>	<i>iv</i>
<i>TaiwanNCC Warning Statement.....</i>	<i>iv</i>
Laser Information.....	iv
Battery Notices	iv
<i>Battery charge notice</i>	<i>v</i>
<i>Storage and safety notice.....</i>	<i>v</i>
Warranty	vi

CHAPTER 1

Getting Started	1
Introducing the RH768.....	1
Package Contents	2
Tour of the New RH768	3
Setting up the RH768	5
<i>Installing the Battery Pack.....</i>	<i>5</i>
<i>Charging the Battery</i>	<i>7</i>
<i>LED Status.....</i>	<i>8</i>
<i>Checking the Battery Status.....</i>	<i>8</i>
<i>Connecting the RH768 to a PC.....</i>	<i>9</i>
<i>Turning the RH768 on for the First Time</i>	<i>9</i>
Using the Stylus.....	10

CHAPTER 2

Using the Hardware.....	13
Using Function Keys.....	14
Toggle to Alpha Mode and CAPS	14

APPENDIX I

System Specification	15
-----------------------------------	-----------

APPENDIX II

Worldwide Support	17
--------------------------------	-----------

Getting Started

Introducing the RH768

Thanks for purchasing the RH768 handheld terminal. The RH768 was designed for RFID mobile applications.

RH768 UHF

Unitech's RH768 UHF handheld terminal is a rugged dual technology multi-tag UHF RFID and bar code reader. It can read both EPC Gen 2 RFID tags and comes with embedded RFID middleware and Windows CE 5.0 for easy integration. The RH768 has a battery life of up to 16 hours. Connectivity options include WLAN 802.11b/g and Bluetooth. It has an IP64 rating and 4' (1.2 meter) drop threshold.

Features

- Built-in 1D or 2D Bar Code Scanner & UHF RFID Reader
- IP64 Rated and 4' Drop Threshold
- Windows Embedded Handheld 6.5 Operating System
- WLAN 802.11b/g and Bluetooth Connectivity
- RFID Middleware, supporting Microsoft Biztalk and Oracle Sensor Edge Server
- Support 860~960 MHz
- Support EPC G2 and ISO 18000-C Tag

Package Contents

Make sure the following items are in the Unitech RH768 box:

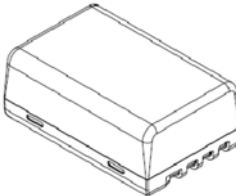
	
<p>RH768 Terminal</p>	<p>Manual CD</p>
	
<p>Power Adapter</p>	<p>Battery Pack</p>
	
<p>Synchronization and Power Cable</p>	

Please contact a regional Unitech service representative if anything is missing or appears damaged.

Tour of the New RH768

Front View



No.	Component	Description
1	Status indicator	Indicates battery and bar code scanning status. Green - Battery charge is complete or a bar code is successfully captured. Red - Battery is charging, bar code scanner is activated and processing.
2	LCD touch screen	Displays the applications and data stored on the device. The screen is touch-sensitive and responds to the stylus or finger.
3	Microphone	Receives Sound.
4	Power button	Press this button to start the RH768. Alternatively, this key must be pressed down for at least two seconds to turn off the RH768.
5	Receiver	Receives the audio signal of a phone call.
6	Scanner trigger button	Press to activate the Bar Code Laser Scanner.
7	Keypad	Keypad interface for controlling the RH768. See the <i>Using the Hardware</i> chapter for more information.

Rear View

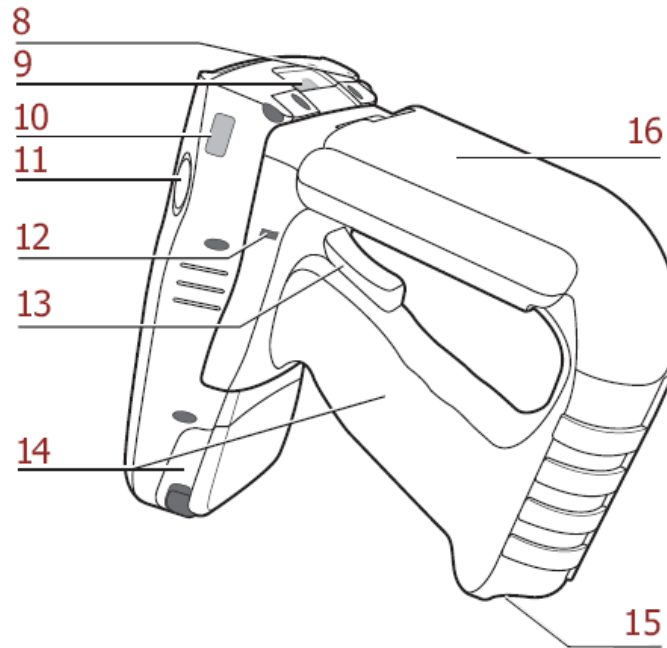

No.	Component	Description
8	Stylus	Remove the Stylus from its holder and hold it like a pen.
9	Bar Code Scanner Window	Scans bar codes.
10	Infrared (IR) Port	Uses infrared technology to transmit and receive data from other IR-enabled devices.
11	Left Scanner Trigger Button	Press to activate the bar code laser scanner.
12	Reset Button	Use a paper clip to press the Reset Button.
13	Bar Code Scanner Trigger	Press to activate the Bar Code Scanner.
14	Battery Compartment	Houses the removable and rechargeable 7.4V Lithium-Ion 4050mAh Battery Pack.
15	Strap Hook	Secures the strap to the RH768.
16	RFID Antenna	Receives data from an RFID tag.

Bottom View

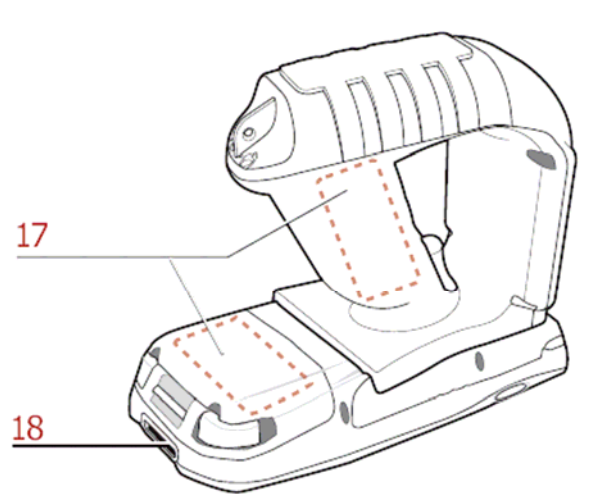

No.	Component	Description
17	Battery Compartment	Houses the rechargeable Lithium-Ion Battery Pack.
18	Universal Connector	Connects the RH768 to the Synchronization Power Cable, which connects to the computer's USB Port. It also connects to the AC Adapter, which plugs into an external power source. This charges the device and performs Microsoft ActiveSync operation.

Setting up the RH768

This section explains how to install and charge the battery, check the battery status, connect the RH768 to a PC, turn on the RH768 for the first time, and calibrate the screen.

Installing the Battery Pack

WARNING! If the battery pack is handled improperly there is a risk of fire or burns. DO NOT disassemble, crush, puncture, short external contacts, or dispose the battery pack in fire or water. DO NOT attempt to open or service the battery pack. Dispose of used batteries according to local recycling guidelines.

The backup battery prevents data loss when the main battery disconnects from the RH768. This backup battery cell will support only the RH768 for a maximum of 72 hours.

NOTE:

- Charge the RH768's main battery pack for at least 16 hours.
- Turn the RH768's Backup Battery Switch to the ON position before initial use.

1. Open the Battery Compartment by sliding the tabs in the direction shown below:

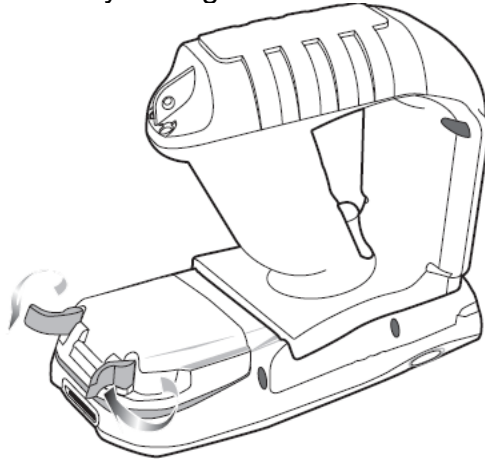

2. Locate the Backup Battery Switch and turn it to the ON position.

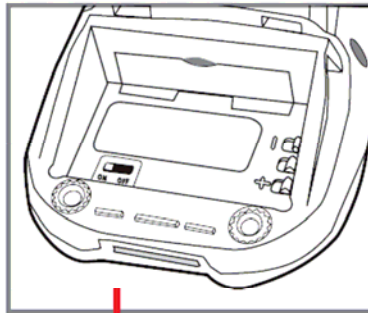

Backup Battery Switch

3. Align the Battery Contacts with the Battery Compartment Contacts as shown below:

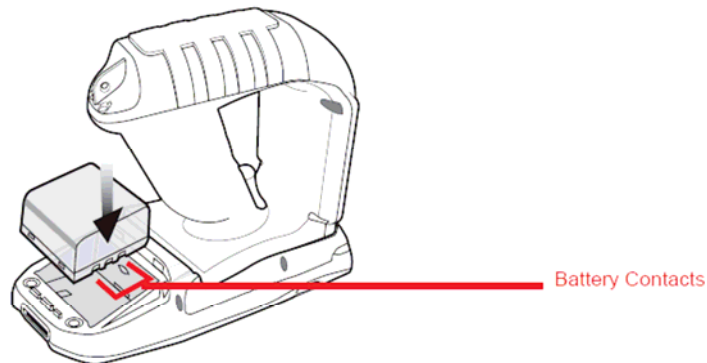

Battery Contacts

4. Place the Battery Pack into the Battery Compartment and press the battery securely into place.

5. Replace the Battery Compartment cover, push down the tabs and slide them back into the lock position as shown below:

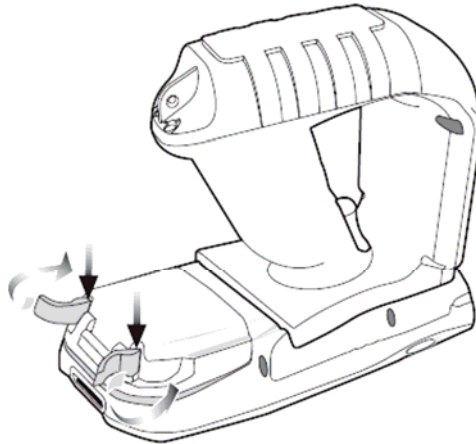

Charging the Battery

Charge the RH768 for at least 16 hours before initial use. Charge the device to full capacity after a full day of use with the Synchronization Power Cable or the Docking Station.

CAUTION! Operating the RH768 for the first time without fully charging the Backup Battery may result in data loss stored in the RAM memory. When the main battery is removed, the backup battery retains data in the RAM memory for 72 hours; charge the battery as soon as possible to avoid data loss.

NOTE: Turn the backup battery switch to the ON position before charging the battery. Data loss may occur if the Backup Battery is not properly charged.

Charging the Battery using the Synchronization Power Cable

1. Press and hold the release button on both sides of the USB charging cable and connect it to RH768 (1).
2. Plug the AC adapter cable into the power jack of the USB charging cable (2).
3. Plug the AC adapter cord into an electrical outlet (3).

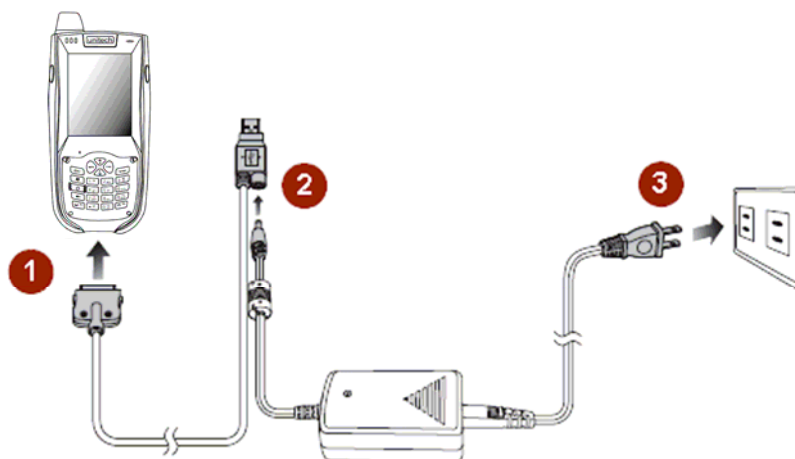

Charging the Battery with the Docking Station

1. Plug the AC Adapter cable into the Docking Station's power jack, and then connect the AC Adapter into an electrical outlet.

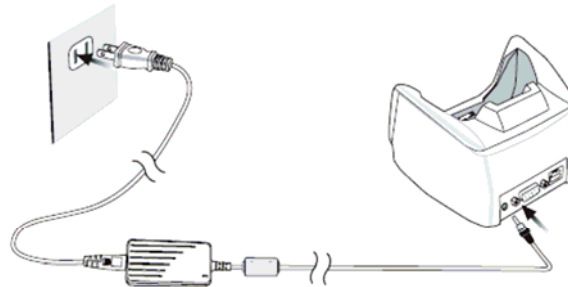

2. Slide the RH768 into the Docking Station until it clicks into place.
3. The connection is secure when the bottom edge of the device aligns with the docking station. (The Docking Station's LED indicator lights up green, while the RH768's LED indicator lights up red.)



Terminal LED indicators
from left to right:
-- GPRS/Bluetooth
Communication
-- Scan
-- Power

Cradle Power/Communication
LED indicator

LED Status

	LED	Status	Description
Terminal	GPRS/Bluetooth	Flashing Yellow	GPRS module is enabled.
		Flashing Blue	Bluetooth module is enabled.
	Scan	Solid Red	Ready for Reading
		Solid Green	Successful reading
	Power	Solid Red	Being charged
		Solid Green	Fully charged
Cradle	Power/Communication	Solid Green	Power is on
		Flashing Green	Data synchronization is active.

Checking the Battery Status

If the battery level becomes low in the course of normal use, a status icon appears on the device screen indicating low or very low battery status. In both cases, perform an ActiveSync operation to back up your data, and then recharge your device as soon as possible.

CAUTION! Once the device is shut down, you should recharge the device within 48 hours. Otherwise you will lose all data including files stored in the RAM memory.

Connecting the RH768 to a PC

Use the Synchronization Power Cable to connect the RH768 to a PC to use Microsoft ActiveSync.

1. Connect the USB Connector jack to the RH768 (1).
2. Plug the USB Connector into a serial port on the PC and connect the AC Adapter into the USB Connector (2).
3. Connect the AC Adapter into an electrical outlet (3).

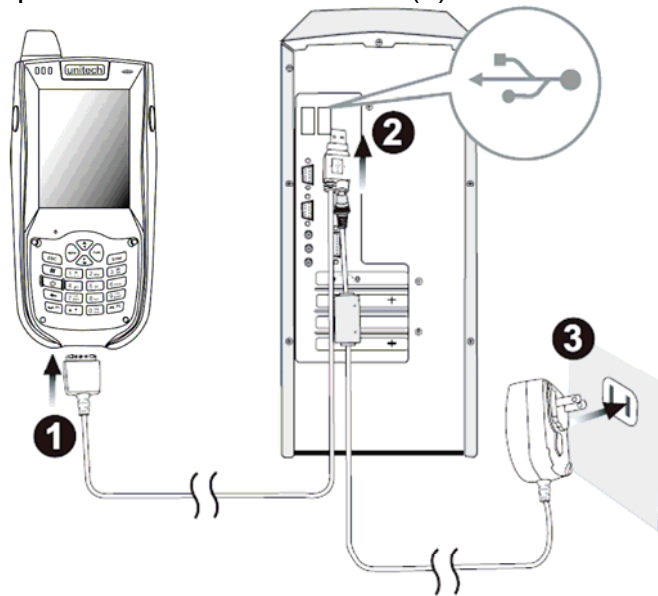

Turning the RH768 on for the First Time

The device is ready for use after it has been charged for at least 16 hours. Start up the device to adjust the screen brightness, calibrate the display, and set up the system time zone, date, and time.

Powering On

1. Turn on the device by pressing the Power Button on the front panel.
2. The Unitech RH768 welcome screen appears followed by the calibration screen.

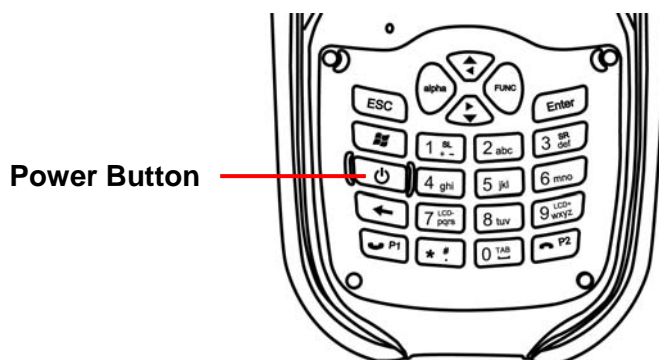

Using the Stylus

CAUTION! Never use anything other than the RH768 stylus on the screen.

1. Remove the stylus from its holder, as shown in the illustration below.
2. Hold the stylus like a pencil.
3. Lightly tap the tip of the stylus to make a menu choice.
4. Double-tap to open programs.
5. Use the stylus to print letters or numbers.

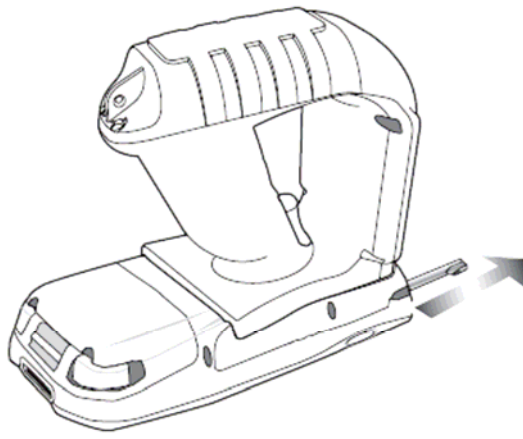

Calibrating the RH768 Screen

The calibration screen automatically appears when the unit is powered on for the first time or after the system is reset.

Access the calibration screen at any time by simultaneously pressing the FUNC and ESC keys.

ESC Key

FUNC Key

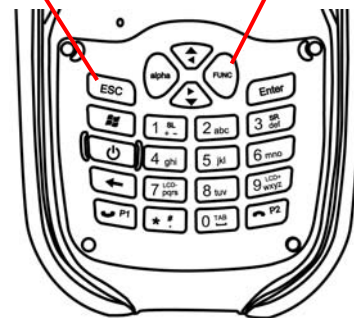

Carefully press and briefly hold stylus on the center of the target. Repeat as the target moves around the screen. Press the Esc key to cancel.



Use a stylus to tap a sequence of target marks on the RH768's screen. Firmly hold the stylus on top of the target mark for a moment, and then remove. Continue to tap the target mark as it stops along the corners of the screen.

Press Enter to confirm the calibration or press ESC key to cancel.

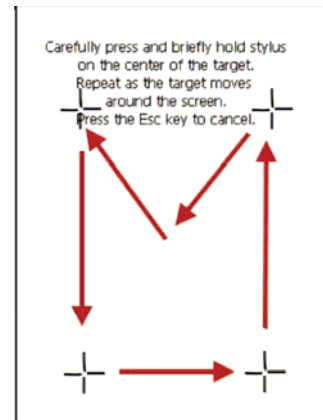

Setting the Time and Date

In the Date/Time Properties window, use the stylus to select the current date and time, time zone, and daylight saving time option.

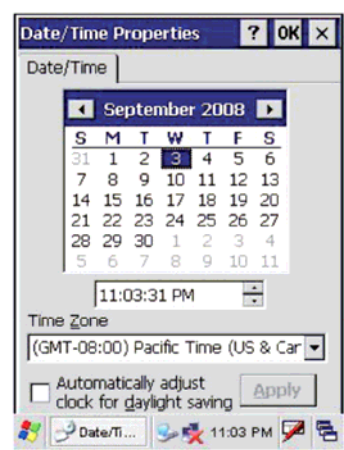





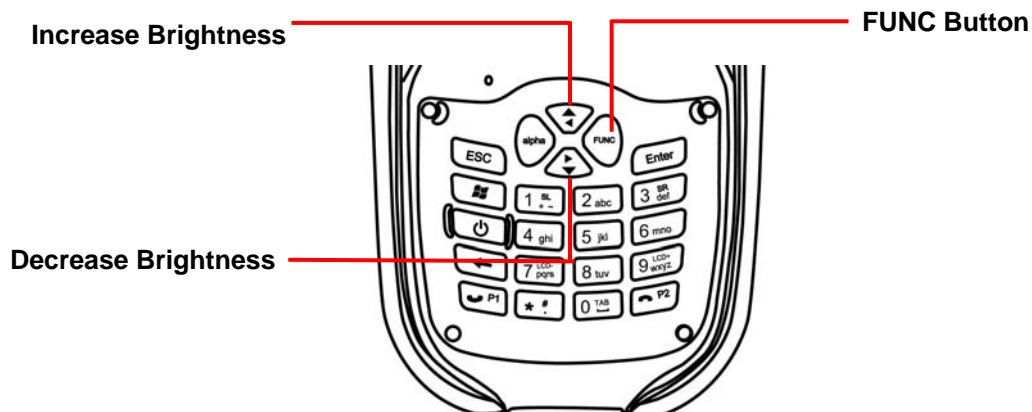







Adjusting the Screen Brightness

Adjust the screen brightness by pressing the FUNC key to enable the soft keys and press the left arrow (decrease brightness) or right arrow (increase brightness) cursor buttons.



Using the Hardware

The following table describes the main keypad keys:

Key	Main Function
	Press this button to turn the RH768 on. Press and hold this button for two seconds to turn the RH768 off.
	Pressing this button corresponds to tapping cancel or X on the screen.
	Press the backspace key to erase characters.
	Press the function key to perform alternative key functions. This key is also used to toggle between upper and lower case alphabetic characters.
	Use the tab key to toggle between fields or to tab forward in word processing applications.
	Press the enter key to confirm an action or entry.
	Use the cursor keys to navigate through applications. Press and hold the Function key and then press the right and left arrows to raise and lower the screen brightness.
	Press the alpha key to toggle between numeric and alphabetic entry modes.
	Press these keys to enter numbers or characters depending on whether the Alpha key has been pressed. Press 0 to enter a space.
	Press this key to add punctuation.
	Press the answer key to answer a call.
	Press the hang-off key to cancel or hang off a call.
	Press the Windows key to launch the start menu.

When RH768 boots, the default condition is Numeric Mode on. When you toggle to Alpha Mode, the default condition is CAPS mode off. Please use the alpha Key to toggle to CAPS.





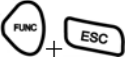
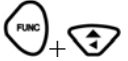
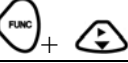
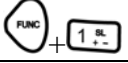
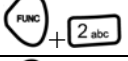
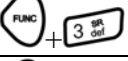
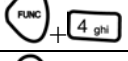
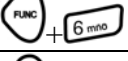
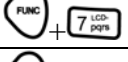
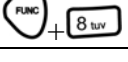
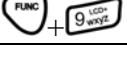





Using Function Keys

The RH768 provides many combination hot keys to activate specified screen setting functions or programs. These hotkeys are useful for calibrating the touch-screen, toggling the backlight, and adjusting screen contrast when the menu-driven operation is disabled. Below is the list of hotkeys. To use them, press and hold Func in combination with the corresponding second key.

Key	Description	Key	Description
	Calibration		Screen backlight toggling
	Keypad backlight toggling		Softkey L
	Softkey R		TALK
	END		Task manager
	Scanner setting		Power management
	Device information		

Toggle to Alpha Mode and CAPS

Numeric Mode is the RH768's default function. In Alpha Mode CAPS is the default condition. Use alpha and Func to toggle into CAPS.

Key	Alpha Off	Alpha On	
		CAPS Off	CAPS On
	0	Space, @, \$, “, 0	Space, @, \$, “, 0
	1	+, -, \, %, 1	+, -, \, %, 1
	2	a, b, c, 2	A, B, C, 2
	3	d, e, f, 3	D, E, F, 3
	4	g, h, i, 4	G, H, I, 4
	5	j, k, l, 5	J, K, L, 5
	6	m, n, o, 6	M, N, O, 6
	7	p, q, r, 7	P, Q, R, 7
	8	t, u, v, 8	T, U, V, 8
	9	w, x, y, z, 9	W, X, Y, Z, 9
	*	, ; ! . /	, ; ! . /

System Specification

CPU	Intel PXA320, 806MHz	
Memory	Mobile DDR: 256MB NaNDFlash: 512MB	
OS	Windows Mobile 6.5.3 Professional/Classic	
Keypad	22-Key, 43-key (optional), including numeric key and alpha key	
Display	480x640 pixel (VGA), 3.5" color transfective TFT-LCD with touch screen & backlight	
Barcode Scanner	1D Laser scanner engine 2D Imager (optional)	
RFID Reader	UHF 860 - 960 MHz, EPCG1 and Gen 2	
Camera	2.0M Pixel	
Flash Light	4800 candle power	
Indicator	LEDs, Vibrator	
Audio	MIC, speaker, headset connector, receiver	
Video	CIF - 352x240 pixel, 15 pix/sec	
Address Locating	GPS	
Expansion Slot	SD memory slot	
Power Source	Main battery	13.69 Watts Li-ion battery pack
	Backup battery	One rechargeable Ni-MH backup battery
Enclosure	Weight	500g with battery
	Dimension	Approximately 199.5mm X 88mm X 43.3mm (Antenna length excluded)
Environmental	Operating temperature	-10 °C ~ 50 °C
	Charging temperature	10 °C ~ 40 °C
	Storage temperature	-20 °C ~ 60 °C
	Relative humidity	5% ~ 95% (non-condensing)

	Drop test to concrete	1.5 Meter
	Environmental sealing	IP65
Models	BT Only	
	WLAN + BT	
	GPRS + BT (for Windows Mobile)	
Regulatory Approvals	CE, FCC, BSMI, VCCI, CCC, RoHS Compliance	
Software	Microsoft Visual Studio 2005 Microsoft Windows Mobile 6.5 SDK (from unitech) Oracle Database Lite Navigator (US, Canada, Europe area)	
Accessories	Desktop USB Cradle USB communication and charging cable AC adaptor (with regional power cord) Vehicle Cradle Battery charger 4 slot Multi-Bay Ethernet Cradle	

Worldwide Support

Unitech's professional support team is available to quickly answer questions or technical-related issues. Should an equipment problem occur, please contact the nearest Unitech regional service representative. For complete contact information please visit the Web sites listed below:

Region	Web Site
Global Operation Center	http://www.ute.com
Unitech Taiwan	http://tw.ute.com
Unitech Asia Pacific & Middle East	http://apac.ute.com ; http://india.ute.com
Greater China Division	http://cn.ute.com
Unitech Japan	http://jp.ute.com
Unitech America	http://us.ute.com ; http://can.ute.com
Unitech Latin America	http://latin.ute.com
Unitech Europe	http://eu.ute.com